

MILITARY SPECIFICATION

CV7083-6 / CV7494

SEMICONDUCTOR DEVICE

Description:- This specification covers the detail requirements for Germanium PNP Power Transistors and is in accordance with Specification K1007, Issue 3, except as otherwise stated.

Mechanical Dimensions and Outlines:- K1007 Section B, 10.3.2.1., 10.3.2.1.1. Type A, 10.4.2.1.

Connections:- 1 - Base, 2 - Emitter, Case - Collector.

Absolute Maximum Ratings:-

Rating	V_{CB}					V_{CE}	V_{EB}	I_{CAV}	I_{CM}	I_{EAV}	I_{EM}	I_{BAV}
	CV7083	CV7084	CV7085	CV7086	CV7494							
Unit	V	V	V	V	V	See rating curves on Pages 14-17	V	A	A	A	A	A
Min.												
Max.	-60	-60	-80	-80	-100		-40	8	10	9	12	1
Note							1					

Rating	I_{BM}	P_{tot}	T_{stg}	T_m	Shock	Vibration
Unit	A	W	°C	°C	g	g
Min.			-55			
Max.	2	38	+85	+90	1500	20
Note		2			3	

- Notes:-
- At $I_C = 0$.
 - See derating curve on Page 11.
 - 0.5 ms duration.
 - Commercial equivalents:-
 CV7083 - 0C29
 CV7084 - 0C35
 CV7085 - 0C28
 CV7086 - 0C36
 CV7494 - 0C20

CV7083-6 / CV7494

Primary Electrical Characteristics

Characteristic	I _{CBO}	I _{CBO}	I _{CBO}	V _{CE} (sust.)					V _{CE} (sat.)	V _{BE}	V _{BE}
				CV7083	CV7084	CV7085	CV7086	CV7494			
Unit	mA	mA	mA	V	V	V	V	V	V	V	
Min.				35	35	60	37	75			
Max.	0.1	3.0	12.0						0.5	1.6	
Conditions	V _{CB}	V	-0.5	Rated Max.						0	
	V _{EB}	V									
	I _C	A			5	5	5	5	6		
	I _E	A	0	0						1.0	
	I _B	mA							600		
	T _m	°C	25	25	85						

Characteristic	Unit	h _{FE}					f _{hfb}
		CV7083	CV7084	CV7085	CV7086	CV7494	
Unit							kc/s
Min.		45	25	20	30	25	200
Max.		130	75	55	110	75	
Conditions	V _{CB}	V	0	0	0	0	-12
	V _{EB}	V					
	I _C	A					
	I _E	A	1.0	1.0	1.0	1.0	1.0
	T _m	°C					

CV7083-6 / CV7494

APPLICABLE DOCUMENTS:- T.V.C. Information Sheets Nos. 9 and 10.

REQUIREMENTS:-

Marking According to K1007, Section B, 1.3.4. omitting (b) from 1.3.4.1.

QUALITY ASSURANCE PROVISIONS:-

Destructive Tests The tests listed in Table II, Group B Inspection, Sub-groups 2, 3 and 4 and in Table III, Group C Inspection, Sub-group 2 are considered destructive.

Group C Inspection Inspection shall be conducted on the initial lot and thereafter every ninety days or every fifth lot whichever occurs first.

PREPARATION FOR DELIVERY:-

Packaging The device shall be packed according to K1007 Section A1.2(c). Washer and two bushes as shown on Page 13 shall be packed with each device.

NATO STOCK NUMBERS:-

CV7083	5960-99-037-2158
CV7084	5960-99-037-2159
CV7085	5960-99-037-2160
CV7086	5960-99-037-2161
CV7494	5960-99-037-3710

This specification has been prepared by and the Qualification Approval Authority is:-

Admiralty Surface Weapons Establishment,
Portsdown, Cosham,
Portsmouth, Hants, England.

GROUP A INSPECTION

Table I

Examination or Test	Test Conditions		AQL %	Insp. Level	Symbol	Limits		Units
	K1007/ NATO Ref.	Specific Conditions				Min.	Max.	
<u>SUB-GROUP 1</u> Visual and Mechanical Inspection	5.1.1.		0.65	I				
<u>SUB-GROUP 2</u> Collector-Base Cut-off Current (1)	7.2.5.1.	$V_{CB} = -0.5V$ $I_E = 0$	0.65	II	I_{CB0}		0.1	mA
Collector-Base Cut-off Current (2)	7.2.5.1.	$I_E = 0$ CV7083, $V_{CB} = -60V$ CV7084, $V_{CB} = -60V$ CV7085, $V_{CB} = -80V$ CV7086, $V_{CB} = -80V$ CV7494, $V_{CB} = -100V$			I_{CB0}		3.0	mA
Static Forward Current Transfer Ratio (1)	7.3.4.1.	$V_{CB} = 0, +0$ $-0.2V$ $I_E = 1A$ CV7083 CV7084 CV7085 CV7086 CV7494			h_{FE}		45 25 20 30 25	130 75 55 110 75

GROUP A INSPECTION

Table I

Examination or Test	K1007/ NATO Ref.	Test Conditions Specific Conditions	AQL %	Insp. Level	Symbol	Limits		Units
						Min.	Max.	
<u>SUB-GROUP 3</u> Sustaining Voltage	7.2.2.2.2.	Fig. 7.2.2./7 $V_{CC} = -30V$ $L = 0.1H$ $I_C = 5A$ $V_{EB} = 2V$ $+V_g = 2V$ $-V_g = 3V$ Pulse duration $50 \mu s$ $p.r.f. = 4 \text{ c.p.s.}$ Clamping voltage = sustaining voltage + $3V$	4.0	IA		35		V
						CV7083 CV7084 CV7085 CV7086 CV7494	35 60 37 75	V_{CE} (sust.)
Small Signal, Short Circuit, Forward Current Transfer Ratio Cut-off Frequency. Common Base	7.5.1.	$V_{CB} = -12V$ $I_E = 50 \text{ mA}$			f_{hfb}	200		kc/s

GROUP A INSPECTION

Table I

Examination or Test	K1007/ NATO Ref.	Test Conditions Specific Conditions	AQL %	Insp. Level	Symbol	Limits		Units
						Min.	Max.	
<u>SUB-GROUP 3 CONT'D</u>								
Base-emitter Voltage (1)		See Fig. 3 Page 12 $I_E = 1A$			V_{BE}	0.8		V
Base-emitter Voltage (2)		See Fig. 3 Page 12 $I_E = 6A$			V_{BE}	1.6		V
Collector Emitter Saturation Voltage	7.3.3.	$I_C = 6A$ $I_B = 600\text{ mA}$			V_{CE} (sat.)	500		mV
Emitter-Base Cut-off Current	7.2.6.	$I_B = 0$ $V_{BE} = 10V$			I_{EBO}	3		mA
<u>SUB-GROUP 4</u>								
Collector-Base Cut-off Current (3)	7.2.5.1.	$T_m = +85^\circ C$ $I_E = 0$ CV7083, $V_{CB} = -60V$ CV7084, $V_{CB} = -60V$ CV7085, $V_{CB} = -80V$ CV7086, $V_{CB} = -80V$ CV7494, $V_{CB} = -100V$	4.0	IA	I_{CBO}	12		mA

GROUP A INSPECTION

Table I

Examination or Test	Test Conditions		AQL %	Insp. Level	Symbol	Limits		Units
	K1007/ NATO Ref.	Specific Conditions				Min.	Max.	
<u>SUB-GROUP 4 CONT'D</u> Static Forward Current Transfer Ratio (2)	7.3.4.1.	$V_{CB} = 0, +0$ $-0.2V$			h_{FE}	35	80	
		$I_E = 6A$ CV7083 CV7084 CV7085 CV7086 CV7494				20	45	
Static Forward Current Transfer Ratio (3)	7.3.4.1.	$V_{CB} = 0, +0$ $-0.2V$			h_{FE}	22		
		$I_E = 1A$ $T_m = -55^{\circ}C$ CV7083 CV7084 CV7085 CV7086 CV7494				12		

Table II

GROUP B INSPECTION

(See Page 3 Quality Assurance Provisions)

Examination or Test	K1007/ NATO Ref.	Test Conditions Specific Conditions	AQL %	Insp. Level	Symbol	Limits		Units
						Min.	Max.	
<u>SUB-GROUP 1</u> Physical Dimensions	5.1.2.	According to drawings 10.3.2.1., 10.3.2.1.1. Type A, and 10.4.2.1.	6.5	IC				
<u>SUB-GROUP 2</u> Solderability	5.13.		4.0	IA				
Temperature Cycling	5.5.	-55°C to +85°C						
Moisture Resistance	5.3.							
<u>SUB-GROUP 3</u> Vibration Fatigue	5.15.	Non-operating	4.0	IA				
<u>SUB-GROUP 4</u> Omitted								
<u>SUB-GROUP 5</u> Omitted								
<u>SUB-GROUP 6</u> Omitted								

GROUP B INSPECTION

Table II

Examination or Test	Test Conditions		AQL %	Insp. Level	Symbol	Limits		Units
	K1007/ NATO Ref.	Specific Conditions				Min.	Max.	
<u>SUB-GROUP 7</u> High Temperature Life (Non-operating)	6.2.1. 6.6.1.2.2.	$T_m = +85^\circ C$ $t = 1000$ hours	4.0	I				
<u>SUB-GROUP 8</u> Operating Life	6.3. 6.5. 6.6.1. 6.6.1.2.2.	T_m between $+25^\circ C$ and $+85^\circ C$ $V_{cb} > \frac{1}{2} V_{CB}$ max. $P_{tot} = \text{max. value given by derating curve on Page 11 corresponding to the chosen } T_m$	4.0	IA				
<u>Post Test End Points for Sub-groups 2, 3, 7 and 8</u> Collector-Base Cut-off Current (2) Static Forward Current Transfer Ratio (1)	7.2.5.1. 7.3.4.	As in Group A, Sub-group 2 As in Group A, Sub-group 2 CV7083 CV7084 CV7085 CV7086 CV7494			I_{CB0} h_{FE}	3.3	35 22 18 27 22	mA

Table III

GROUP C INSPECTION

(See Page 3 Quality Assurance Provisions)

Examination or Test	Test Conditions		AQL %	Insp. Level	Symbol	Limits		Units
	K1007/ NATO Ref.	Specific Conditions				Min.	Max.	
<u>SUB-GROUP 1</u>								
Omitted								
<u>SUB-GROUP 2</u>			6.5	IA				
Shock	5.17.	Non-operating. Five blows each orientation Y1, Y2, X ₁ and Z ₁						
<u>Post Test End Points for Sub-group 2</u>								
Collector-Base Cut-off Current (2)	7.2.5.1.	As in Group A, Sub-group 2			I _{CBO}		3.3	mA
Static Forward Current Transfer Ratio (1)	7.3.4.	As in Group A, Sub-group 2			h _{FE}			
		CV7083				35	180	
		CV7084				22	80	
		CV7085				18	60	
		CV7086				27	120	
		CV7494				22	80	

TO BE READ IN CONJUNCTION WITH T.V.C. INFORMATION
SHEETS Nos. 9 AND 10.

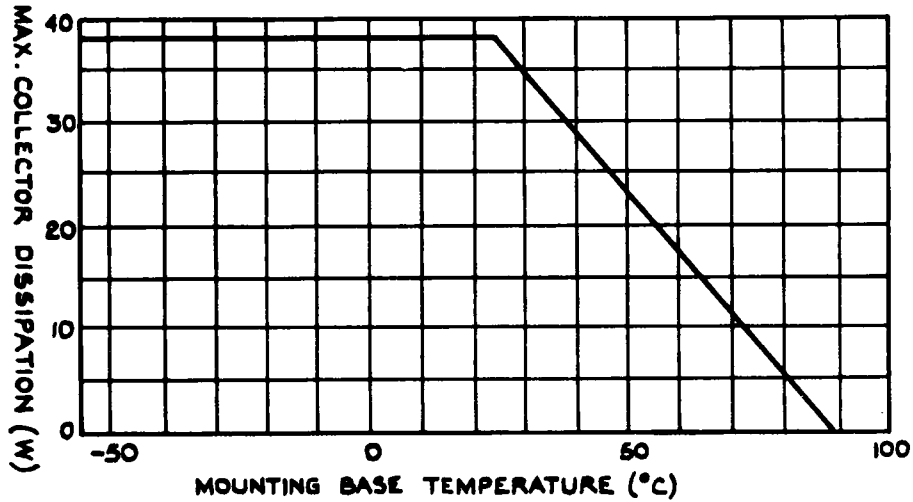

FIG. 1 DISSIPATION RATING - TRANSISTOR
MOUNTED ON HEAT SINK

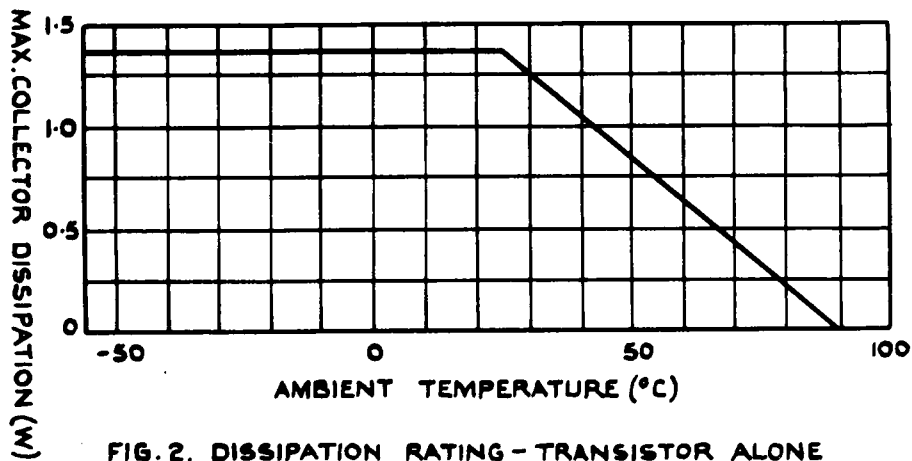

FIG. 2. DISSIPATION RATING - TRANSISTOR ALONE
IN FREE AIR.

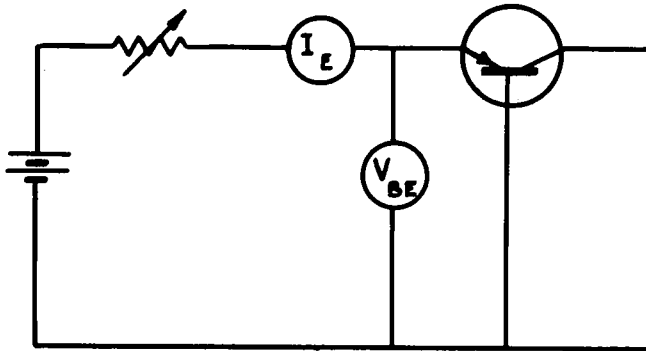
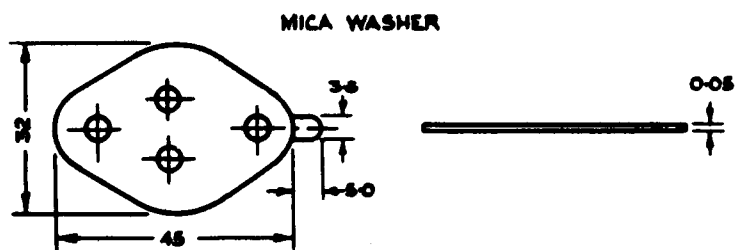

FIG. 3 CIRCUIT FOR MEASURING V_{BE}



ALL DIMENSIONS IN MM.

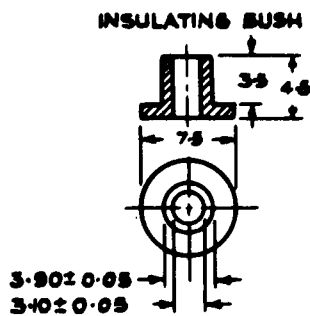
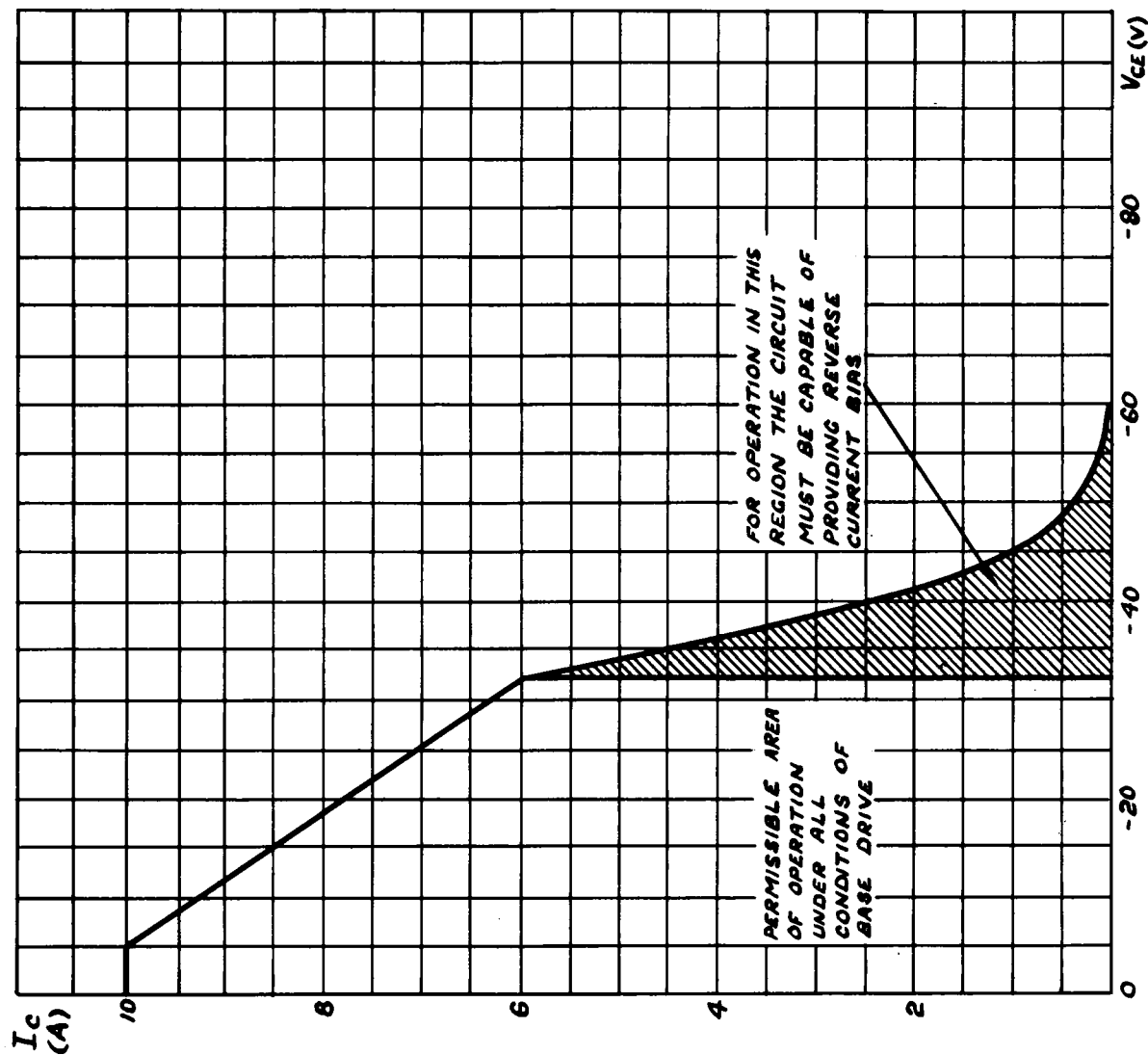
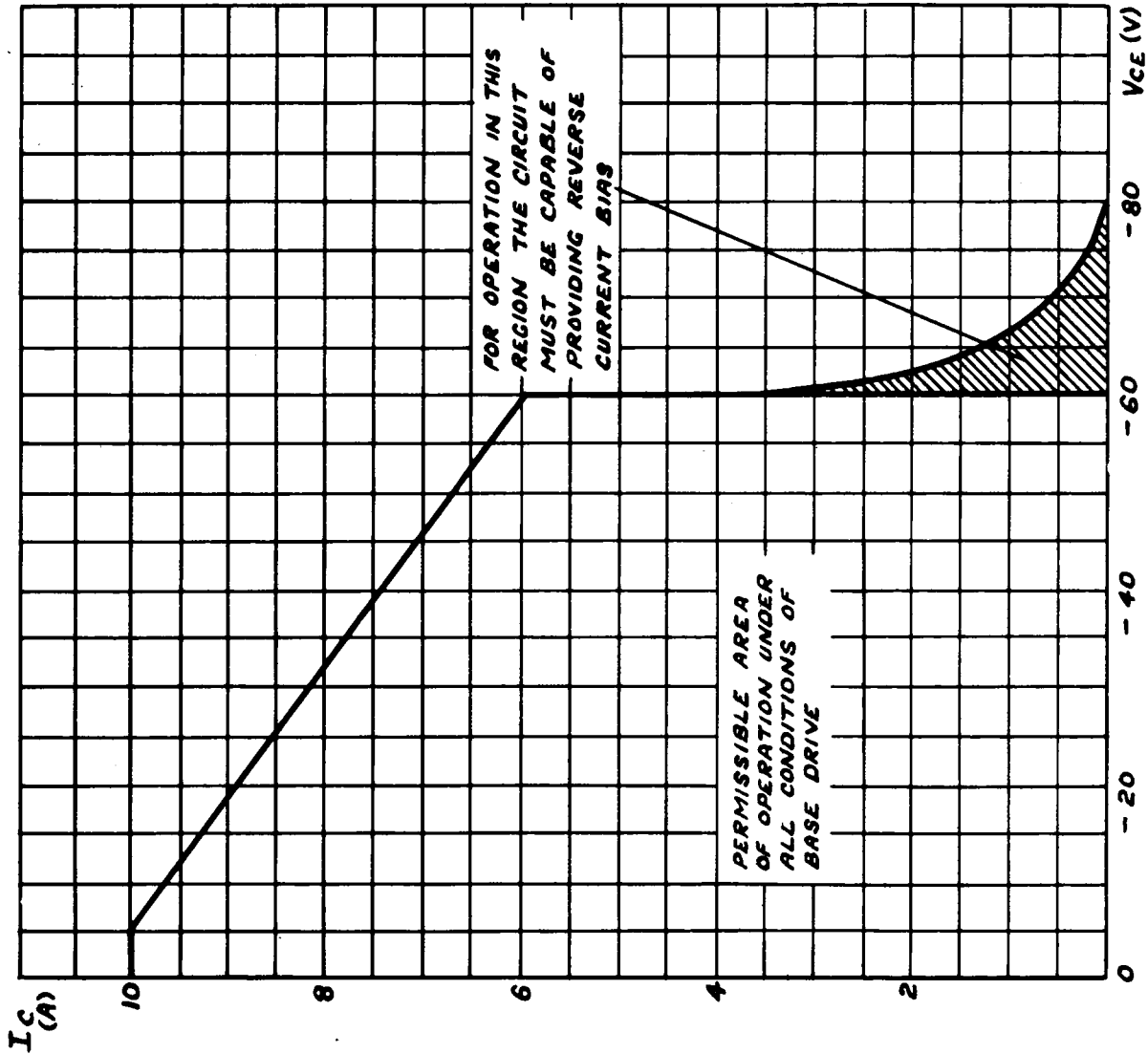

FIG. 4 DETAILS OF ITEMS TO BE SUPPLIED WITH EACH DEVICE.

CV7083-6/CV7494



COLLECTOR CURRENT PLOTTED AGAINST
ABSOLUTE MAXIMUM COLLECTOR-EMITTER
VOLTAGE . CV7083/4



COLLECTOR CURRENT PLOTTED AGAINST
ABSOLUTE MAXIMUM COLLECTOR-EMITTER
VOLTAGE. CV 7085

CV7083 6/CV7494

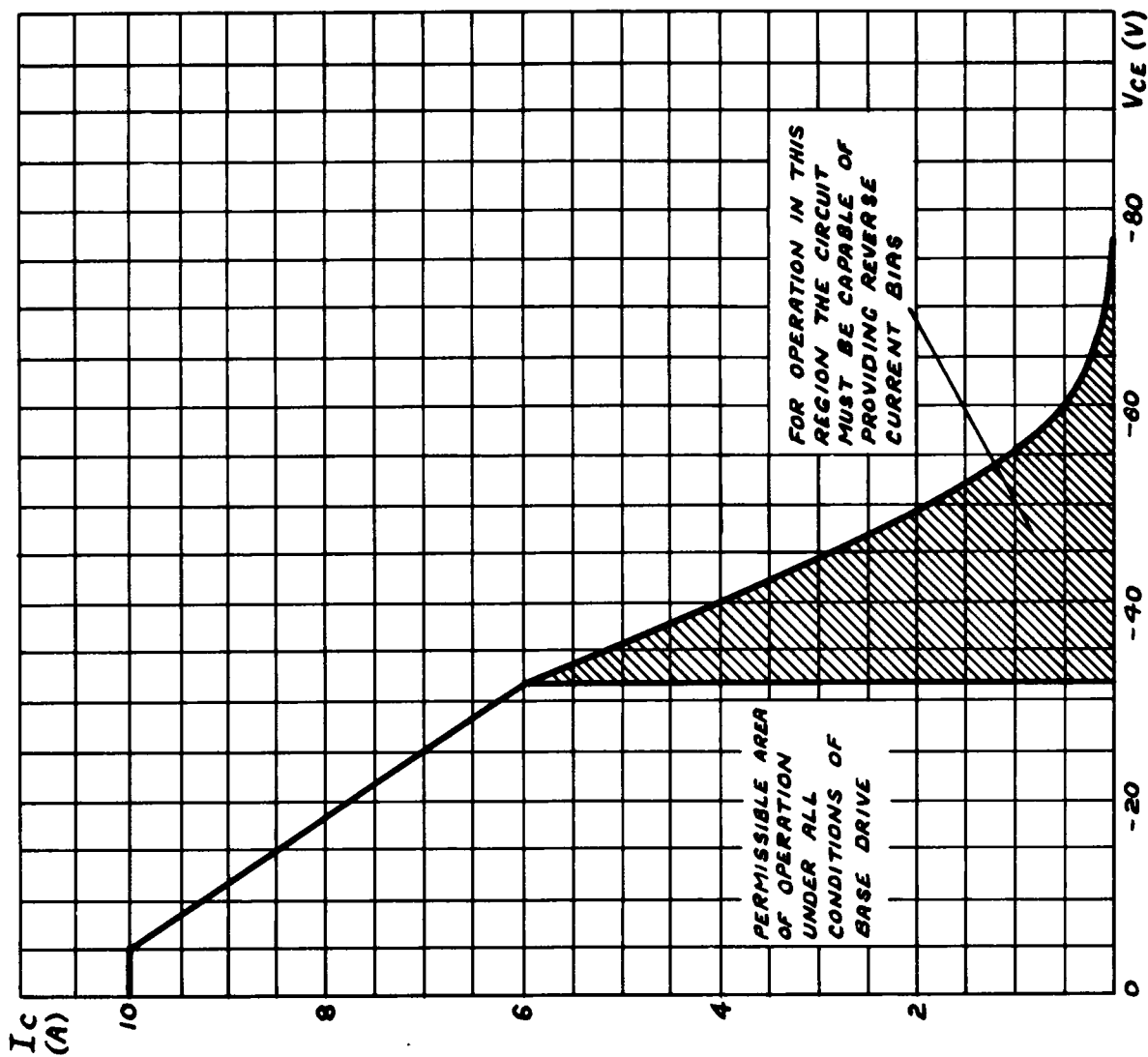

COLLECTOR CURRENT PLOTTED AGAINST
ABSOLUTE MAXIMUM COLLECTOR-EMITTER
VOLTAGE. CV 7086

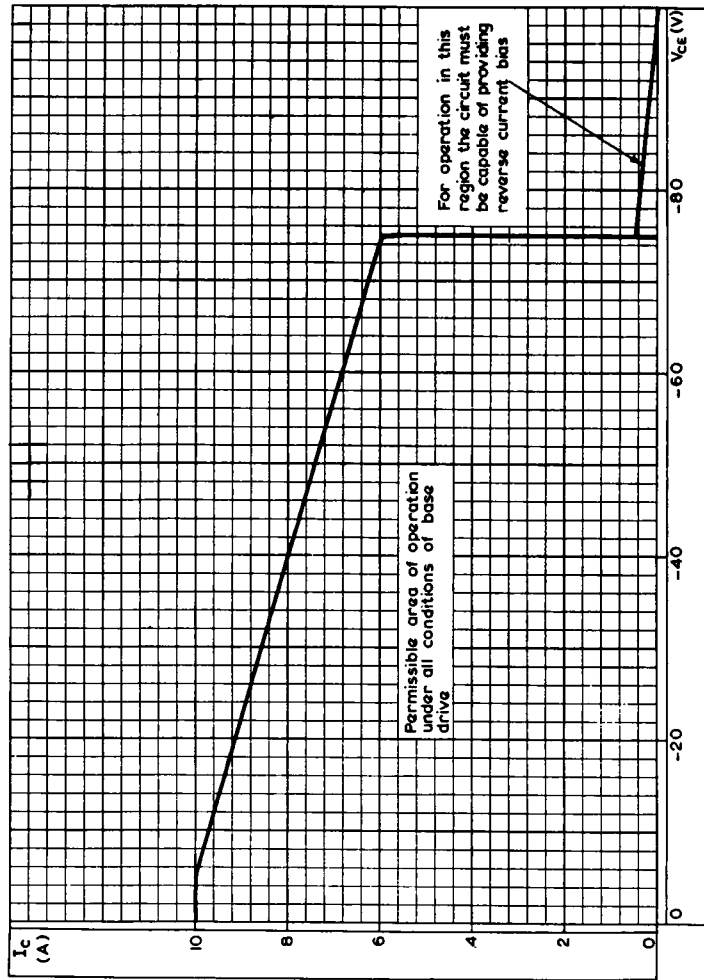

COLLECTOR CURRENT PLOTTED AGAINST ABSOLUTE MAXIMUM COLLECTOR-EMITTER VOLTAGE **CV7494**

CV7083-6 APPLICATION DATA

CV7494

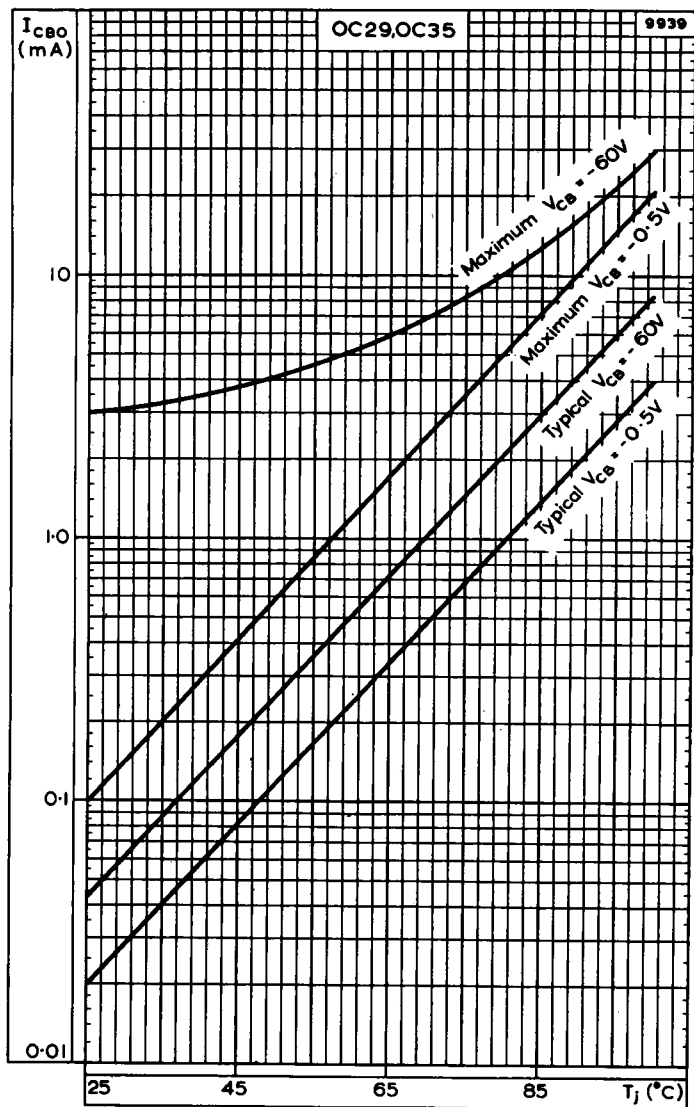

VARIATION OF I_{CBO} WITH JUNCTION TEMPERATURE. OC29, OC35

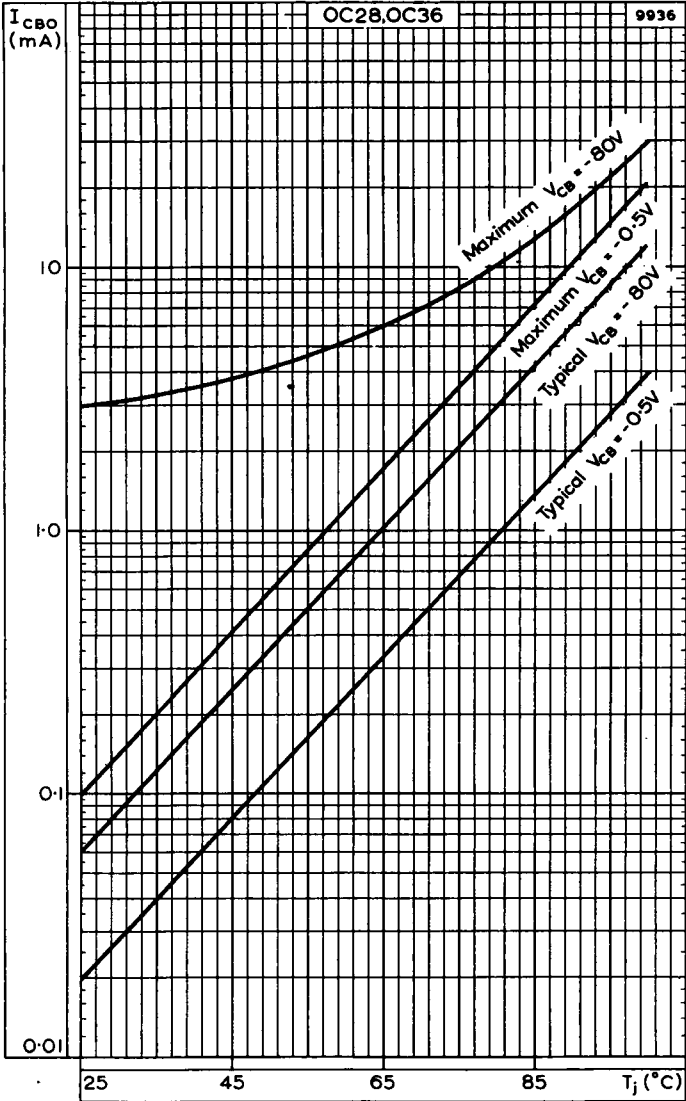

VARIATION OF I_{CBO} WITH JUNCTION TEMPERATURE. OC28, OC36

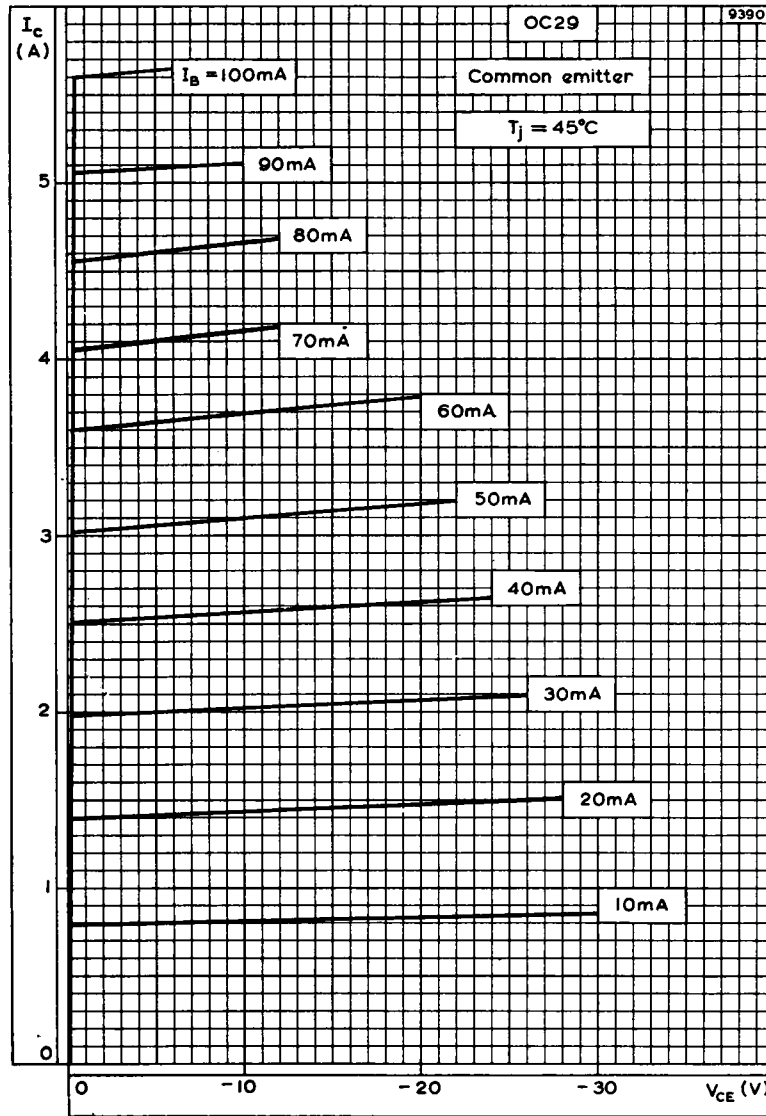

OUTPUT CHARACTERISTIC FOR OC29. COMMON EMITTER

CV7083-6 APPLICATION DATA

CV7494

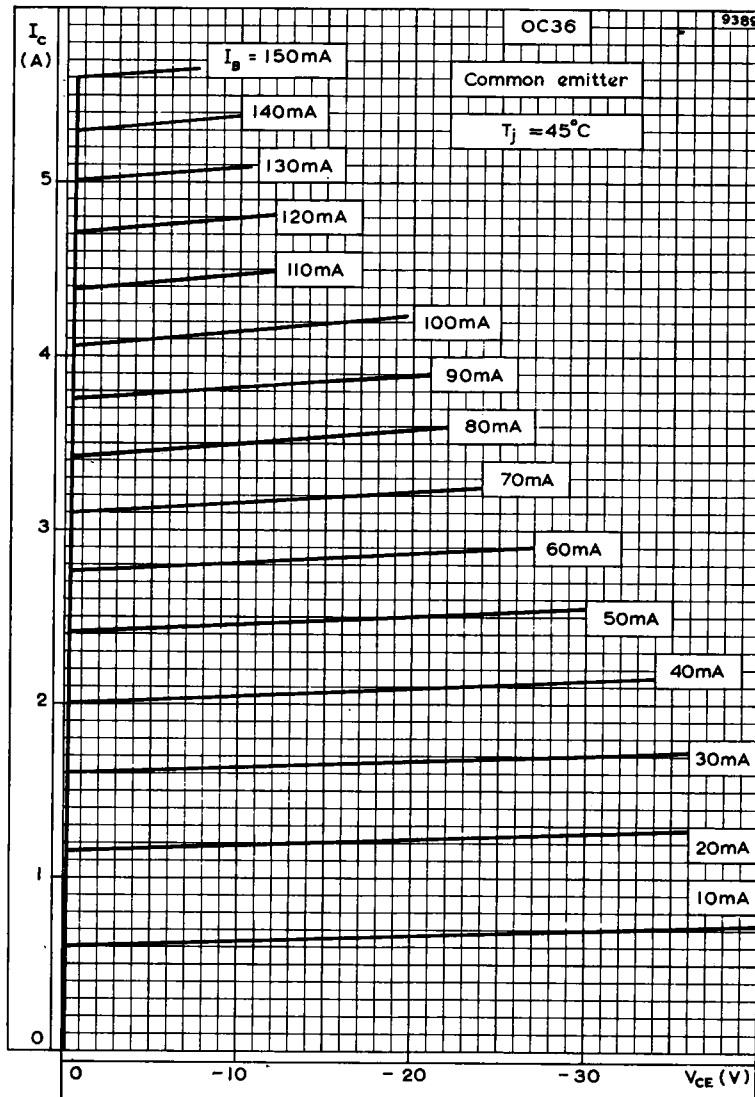

OUTPUT CHARACTERISTIC FOR OC36. COMMON EMITTER

APPLICATION DATA CV7083-6 CV7494

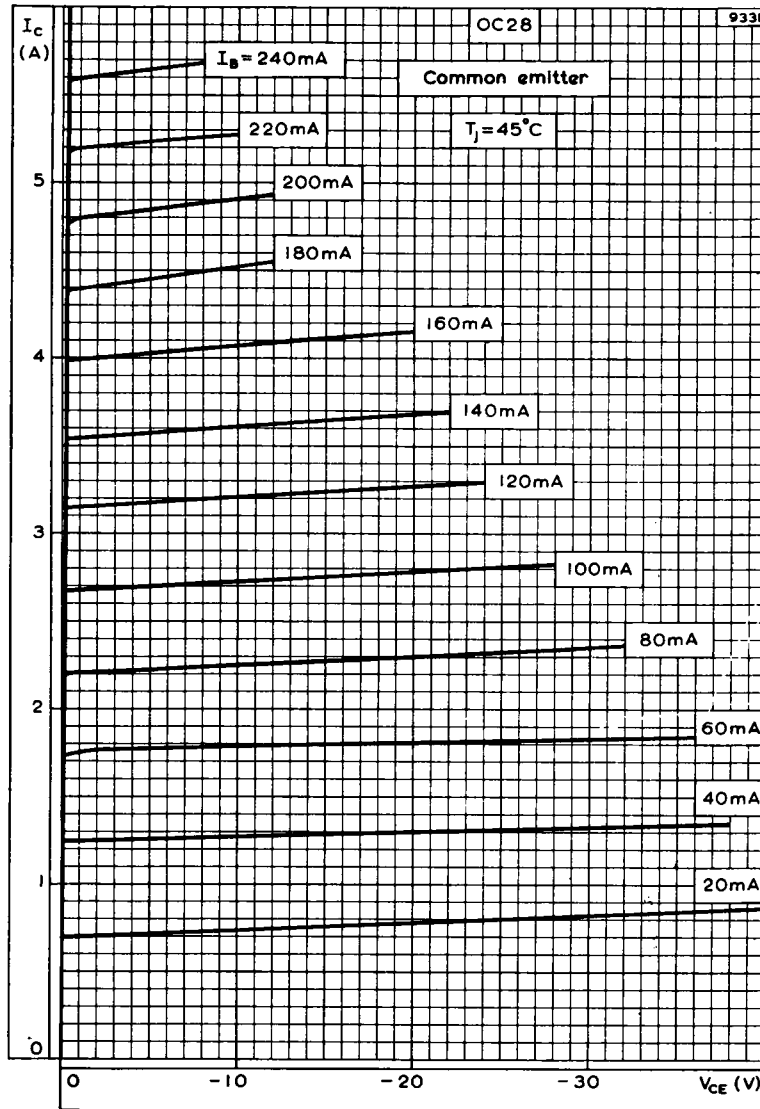

OUTPUT CHARACTERISTIC FOR OC28. COMMON EMITTER

CV7083-6 APPLICATION DATA

CV7494

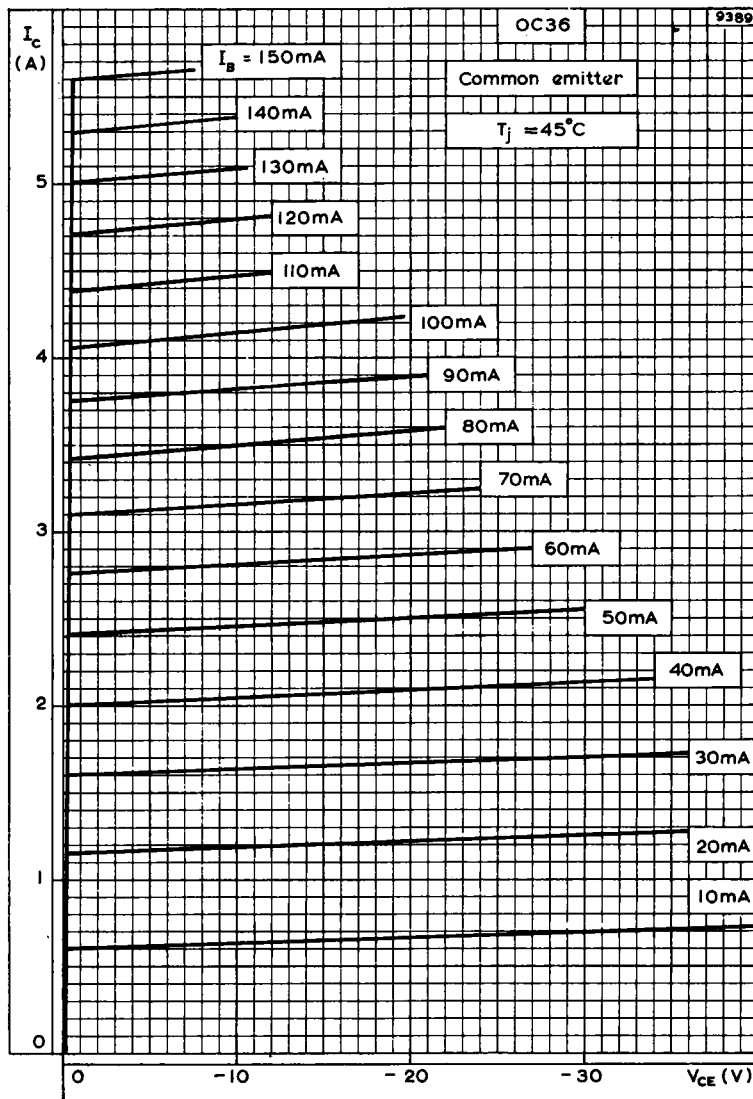

OUTPUT CHARACTERISTIC FOR OC36. COMMON EMITTER

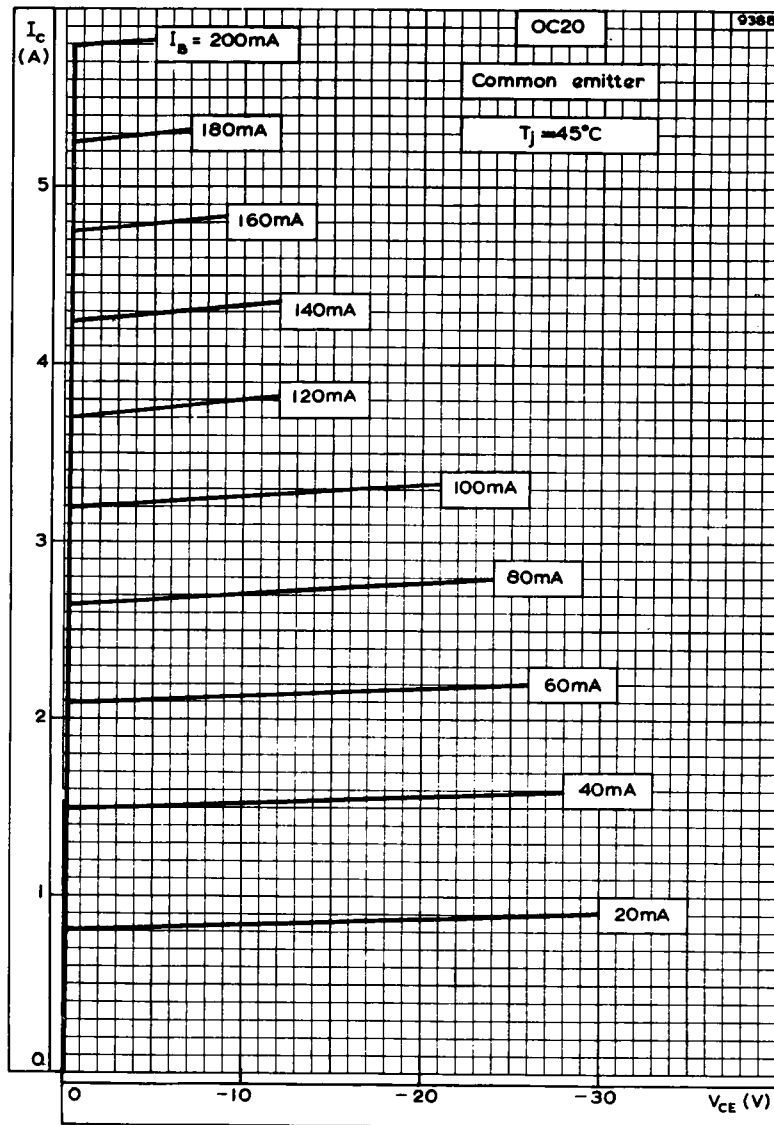

TYPICAL OUTPUT CHARACTERISTICS

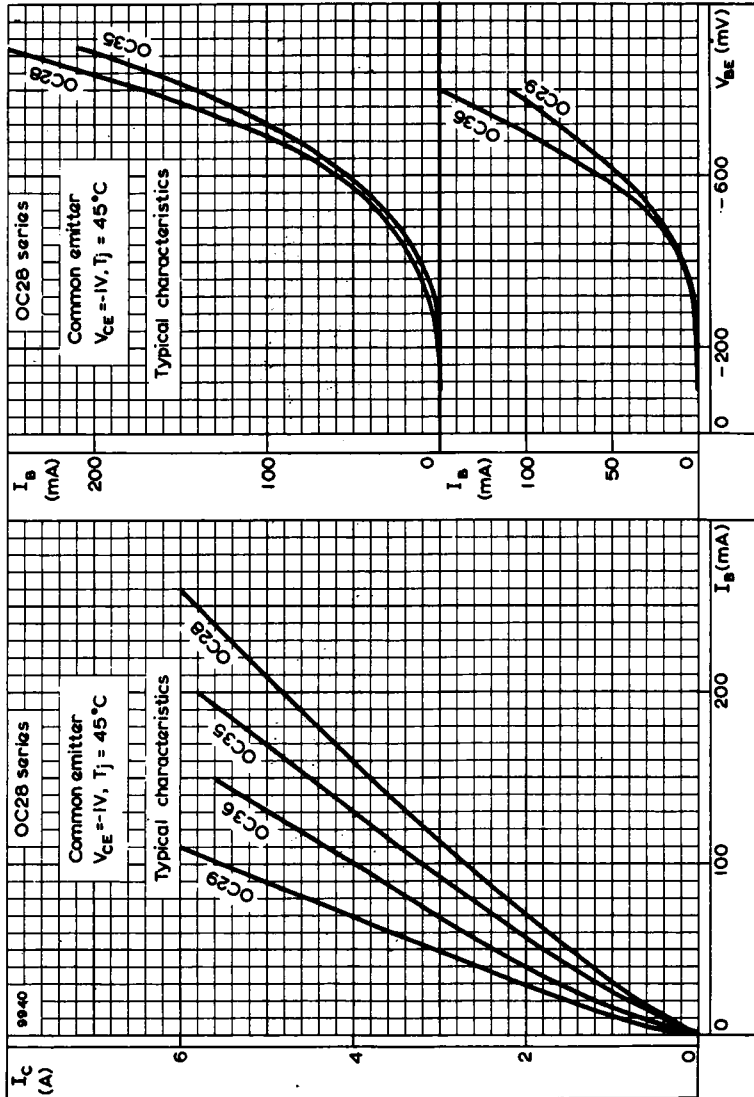

TRANSFER AND INPUT CHARACTERISTICS. COMMON EMITTER

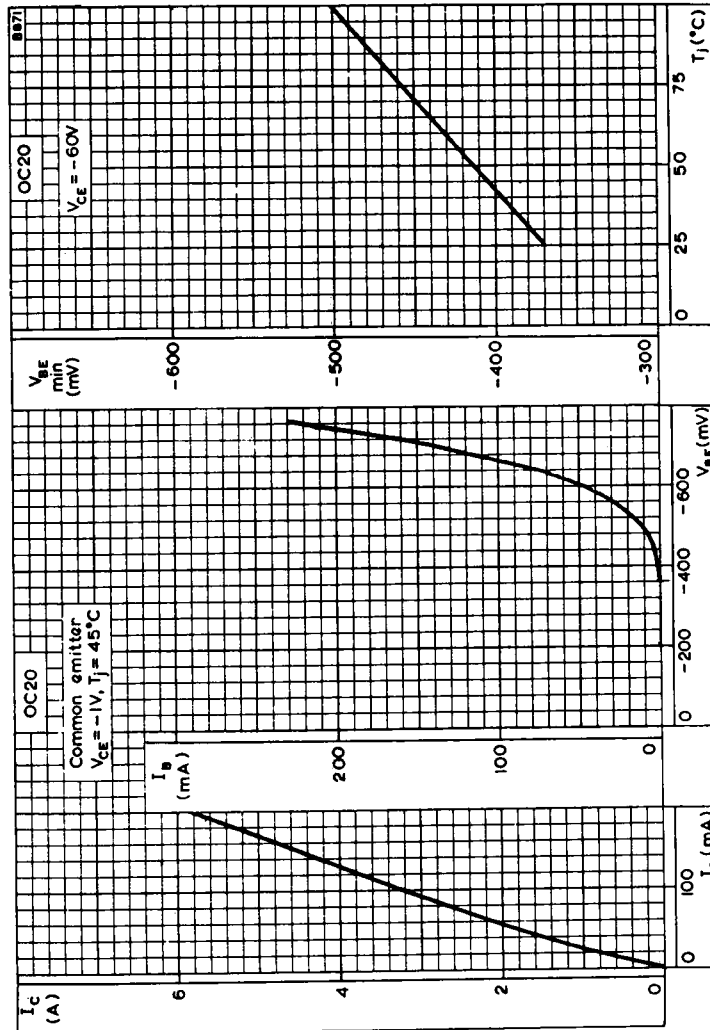

TYPICAL TRANSFER AND INPUT CHARACTERISTICS AND VARIATION OF V_{BE} WITH JUNCTION TEMPERATURE

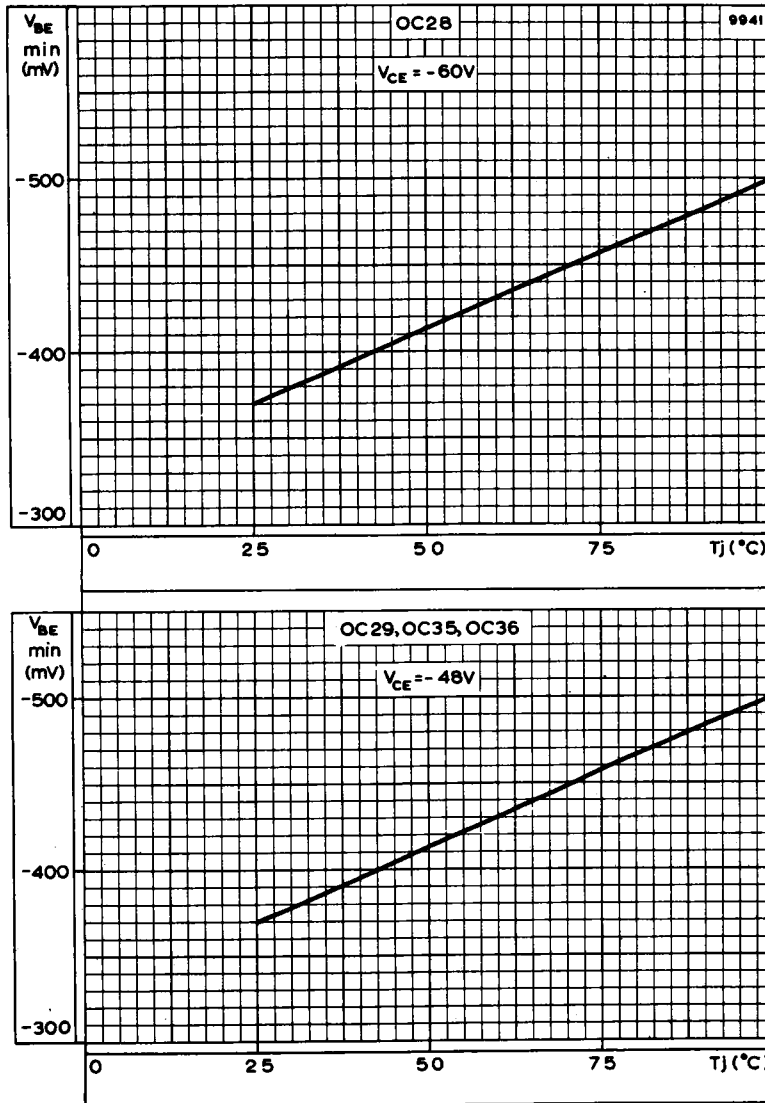

VARIATION OF V_{BE} WITH JUNCTION TEMPERATURE

Typical operation in on-off power switching circuit

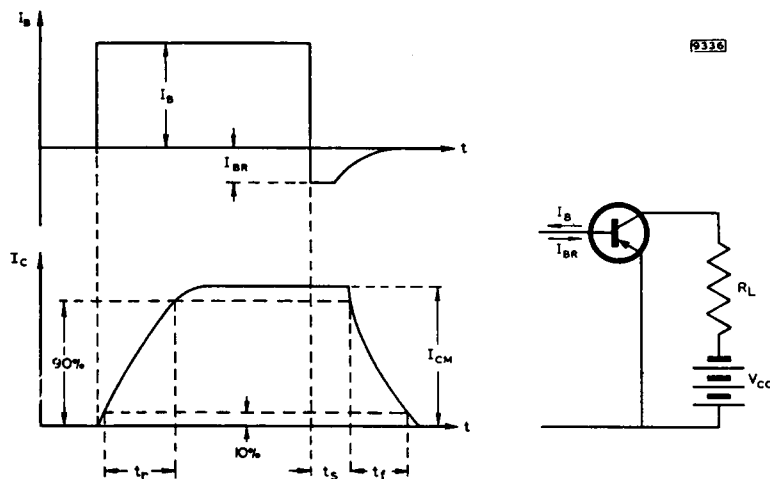

Fig. 2

D.C. supply voltage	V_{CC}	14		28		V				
Load resistance	R_L	14	2.3	28	4.7	Ω				
peak collector current	I_{CM}	1.0	6.0	1.0	6.0	A				
'Turn On' base current	I_B	OC29 35	OC35 OC20 55	OC29 260	OC35 OC20 400	OC28 OC36 70	OC28 OC36 50	480	400	mA
'Reverse' base current	I_{BR}	8.7	13.7	65	100	17.5	12.5	120	100	mA
Switching times										
Rise time	t_r	20	20	20	20	μs				
Storage time	t_s	15	15	15	15	μs				
Fall time	t_f	40	35	40	35	μs				

$$\text{Rise time } t_r = \frac{\beta}{\omega 1} \log_e \frac{h_{FE} |I_B|}{h_{FE} |I_B| - |I_{CM}|}$$

$$\text{Fall time } t_f = \frac{\beta}{\omega 1} \log_e \left[1 + \frac{|I_{CM}|}{h_{FE} |I_{BR}|} \right]$$

$$\text{Storage time } t_s = \tau_s \log_e \frac{|I_B| + |I_{BR}|}{\frac{|I_{CM}|}{h_{FE}} + |I_{BR}|}$$